

**SIEMENS**

Symbia Evo  
Excel

[www.siemens.com/symbia-evo-excel](http://www.siemens.com/symbia-evo-excel)

# Symbia Evo Excel

Small is the new big.

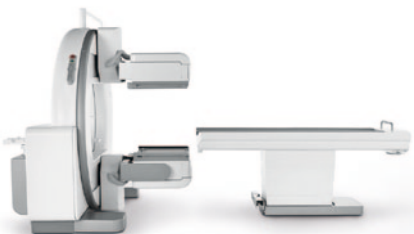

Answers for life.

Small on the outside, yet big on the inside,

# Symbia Evo Excel<sup>1</sup>

empowers you to image every patient<sup>2</sup> knowing you have the clinical information needed for confident decision making and a system designed to optimize your investment.

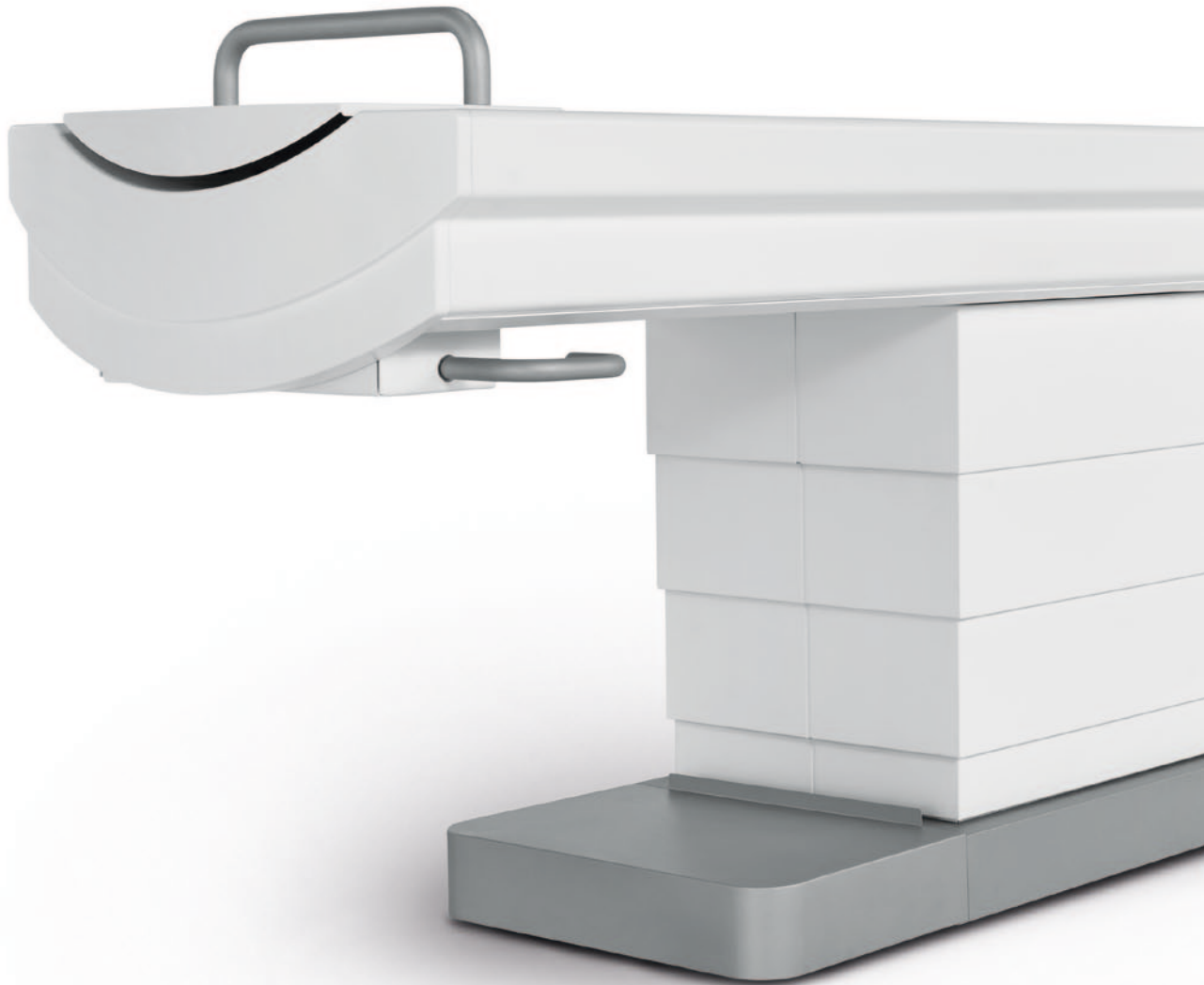



# Small is the new big.

Siemens introduces Symbia Evo™ Excel, a cutting-edge SPECT system featuring the smallest<sup>3</sup> room size in its class. Designed with your needs in mind, Symbia Evo Excel demonstrates that quality and flexibility can be achieved without compromising your budget. The system is smaller, more powerful and accommodates virtually all patients<sup>2</sup>. Symbia Evo Excel is everything you need and nothing you don't.

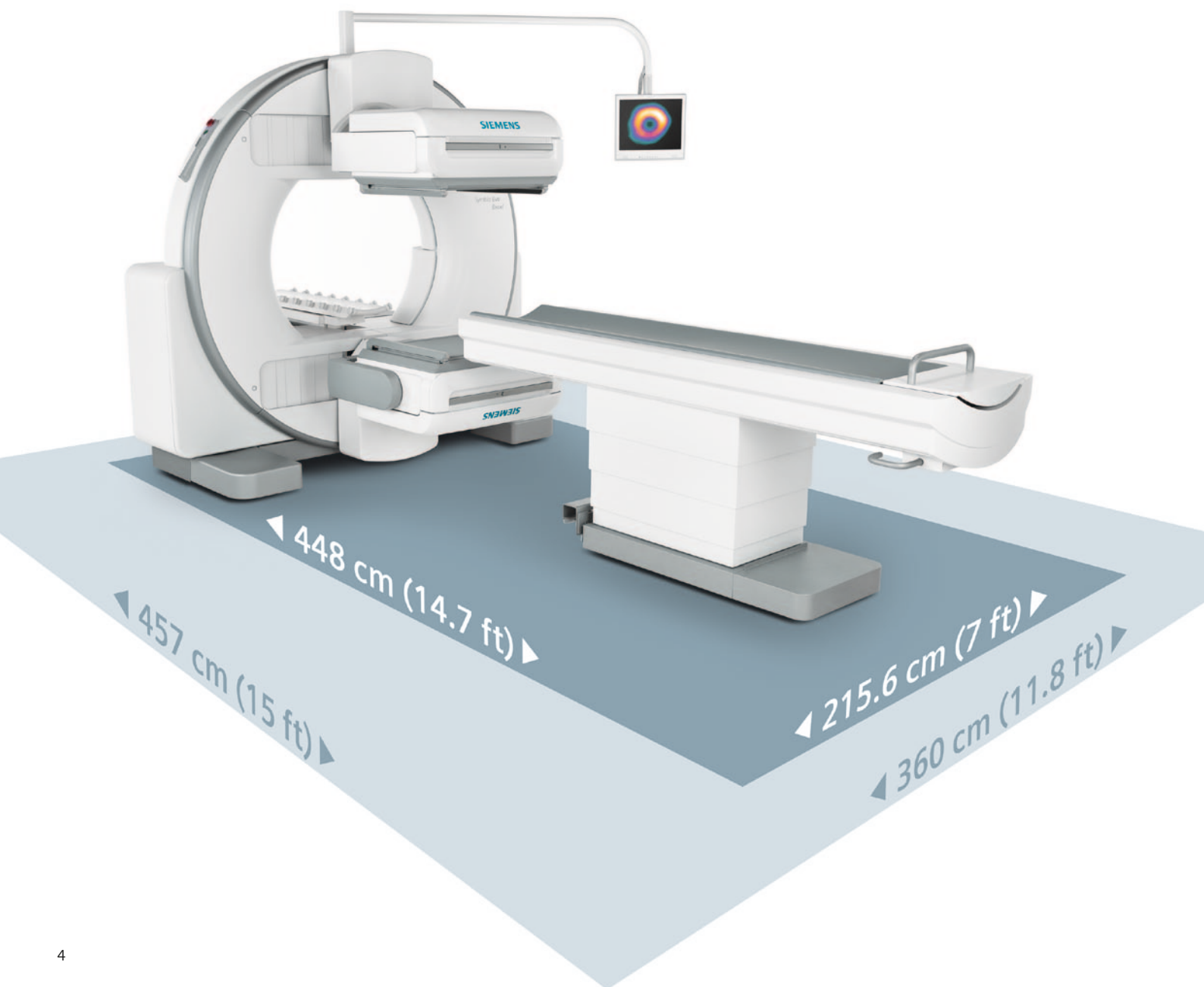

## Optimize your investment

- Challenge** Modernization is essential when managing the pressing demands of today's healthcare environment. With conventional SPECT systems, this often requires substantial time and cost, which includes renovation of existing infrastructure and additional unplanned spending.
- Solution** Engineered to manage key life-cycle costs, Symbia Evo Excel is the most cost-effective solution in its class. The system design addresses space requirements, as well as maintenance and serviceability, making it an investment that works for you.
- Benefit** With the smallest<sup>3</sup> room size requirement in its class, up to 29%<sup>3</sup> smaller than conventional SPECT systems, Symbia Evo Excel significantly reduces costs associated with room remodeling and expansion. Lower up-front costs mean a faster return on investment, while lower life-cycle costs equate to a lower total cost of ownership.

## Image every patient<sup>2</sup>

- Challenge** Delivering high-quality care means being able to scan every patient<sup>2</sup> regardless of their size, weight or condition. Most SPECT systems today are limited in their ability to image large patients and often are not flexible enough to accommodate critically ill patients who may not be able to easily move.
- Solution** With exceptional detector flexibility, Symbia Evo Excel supports gurney and hospital bed imaging. The streamlined bed supports patients up to 227 kg (500 lbs), while the lowest bed position offers easy access to patients with limited mobility.
- Benefit** Increase your scannable population and improve patient comfort with a 30%<sup>4</sup> larger bore; a high-capacity, low-height patient bed; and gurney and hospital bed imaging capabilities.

## Read with confidence

- Challenge** Reliable and reproducible clinical information is vital to support sound physician decision making. The low sensitivity and sub-par reconstruction techniques of traditional SPECT systems can limit the amount of clinical information available to physicians.
- Solution** Equipped with leading high-definition (HD) detector technology, Symbia Evo Excel offers the highest<sup>3</sup> collimator sensitivity and the best<sup>3</sup> NEMA-reconstructed resolution.
- Benefit** With industry-leading<sup>3</sup> image quality, Symbia Evo Excel delivers accurate and reproducible clinical information to support physicians' diagnostic confidence, potentially leading to improved clinical outcomes and reduced readmission rates.

# Optimize your investment

Symbia Evo Excel's room size requirement is up to 29%<sup>3</sup> smaller than conventional SPECT scanners. As a result, healthcare institutions save costs associated with room construction, system installation and daily operation.

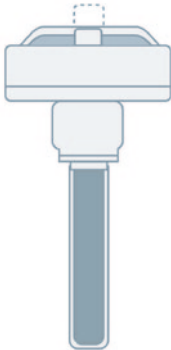
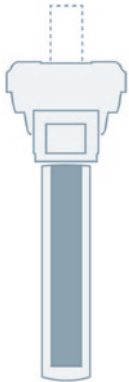
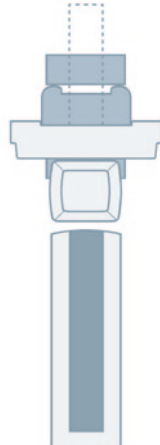
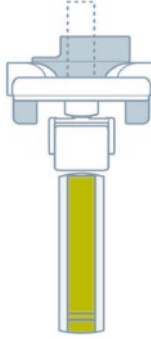
	Vendor A	Vendor B		Symbia Evo Excel	% Smaller
					
<b>Length</b>	4.72 m (15.5 ft)	5.12 m (16.8 ft)	5.49 m (18.0 ft)	4.57 m (15 ft)	- 20%
<b>Width</b>	3.66 m (12.0 ft)	3.74 m (12.3 ft)	3.86 m (12.7 ft)	3.60 m (11.8 ft)	- 7%
<b>Footprint</b>	17.3 sq m (186 sq ft)	19.1 sq m (206 sq ft)	21.2 sq m (228 sq ft)	16.5 sq m (177 sq ft)	- 29%

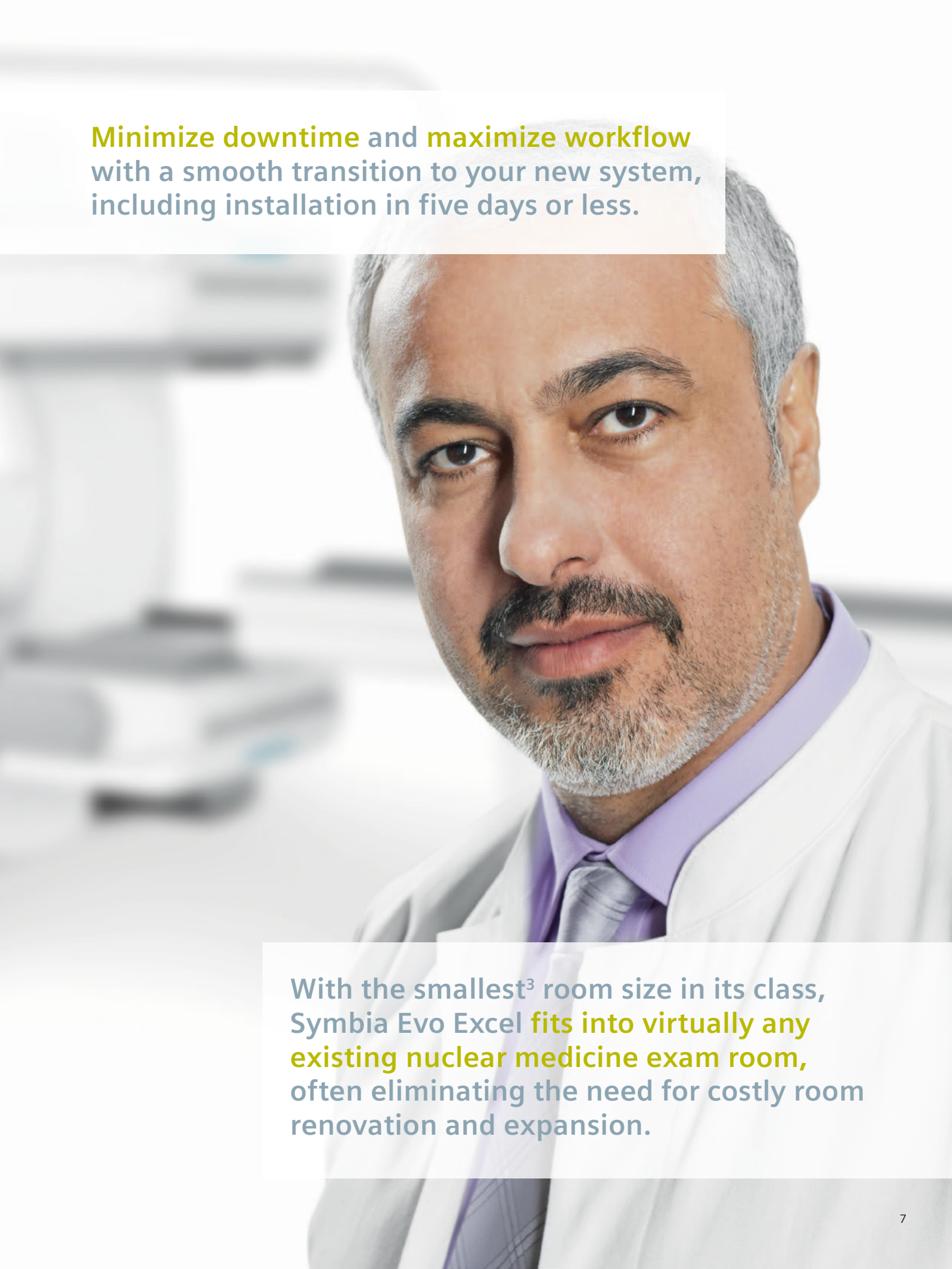

**Minimize downtime** and **maximize workflow** with a smooth transition to your new system, including installation in five days or less.

With the smallest<sup>3</sup> room size in its class, Symbia Evo Excel **fits into virtually any existing nuclear medicine exam room**, often eliminating the need for costly room renovation and expansion.

# Image every patient<sup>2</sup>

Your return on investment starts with the ability to scan virtually any<sup>2</sup> patient regardless of their size, weight or condition. With a higher bed capacity, larger<sup>4</sup> bore and exceptional detector flexibility, Symbia Evo Excel increases your scannable population.



## Detector versatility

Symbia Evo Excel's detector heads easily rotate into numerous positions, including caudal/cephalic tilt, offering comprehensive imaging positions for general purpose, cardiology, oncology and neurology studies, regardless of patient condition and size<sup>2</sup>. This unique versatility enables faster patient set-up for ambulatory, wheelchair and gurney planar imaging, making a whole range of otherwise difficult scans possible.





**Improve the comfort and satisfaction of large or claustrophobic patients** with a 30% larger bore and shorter tunnel length, compared to previous systems.



**SIEMENS**

1 •

Symbia Evo  
Excel

**Accommodate all patients** up to 227 kg (500 lbs) with Symbia Evo Excel's high-capacity bed.

# Read with confidence

Symbia Evo Excel supports physicians' ability to read every scan with confidence, potentially reducing the need for additional studies. Advanced HD detector technology, combined with the lowest<sup>3</sup> pallet attenuation, highest<sup>3</sup> collimator sensitivity and industry-leading<sup>3</sup> reconstruction algorithms, this system delivers high-quality SPECT images to facilitate physician decision making.

## LEHR collimator sensitivity

### Conventional collimators

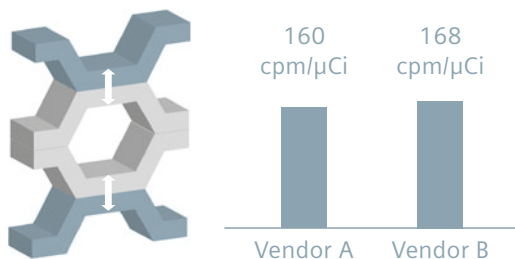

### Siemens collimators

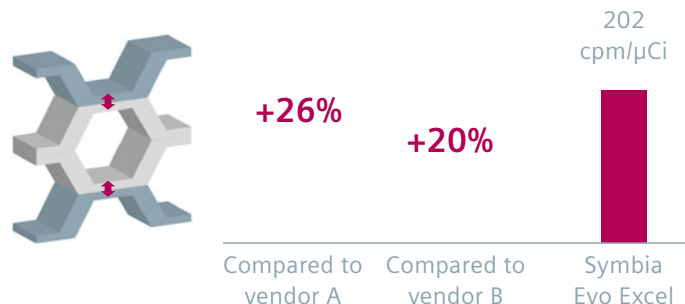

Siemens is the only equipment manufacturer that designs and produces its collimators in-house. The uniform septa wall thickness of Siemens AUTOFORM collimators delivers the industry's highest<sup>3</sup> sensitivity with up to 26%<sup>3</sup> more counts, while maintaining image resolution.

## NEMA-reconstructed resolution

NEMA measurements	Vendor A	Vendor B	Symbia Evo Excel		Up to % higher resolution
			Without scatter	With scatter	
Center resolution	5.2 mm	5.0 mm	4.4 mm	5.8 mm	+15%
Radial resolution	5.0 mm	5.7 mm	4.0 mm	5.0 mm	+20%
Tangential resolution	5.1 mm	5.1 mm	3.9 mm	4.1 mm	+24%

With Symbia™ 3D iterative reconstruction (Flash 3D), the spatial resolution of the collimator is modeled to maintain the precise shape of the lesion. As a result, images are reconstructed with more counts in the correct volume, increasing image contrast. When compared to traditional reconstruction methods, Flash 3D offers up to 24%<sup>3</sup> higher resolution to support physicians in both lesion detection and characterization.



**Reduce the need for additional studies** with outstanding image quality and industry-leading<sup>3</sup> NEMA sensitivity of 202 cpm/ $\mu$ Ci.

**Improve lesion detection and characterization** with up to 24%<sup>3</sup> higher NEMA-reconstructed resolution.

# Base system highlights

## Intuitive hand controller

Easy-to-use with descriptive controls for more efficient system operation

## Short tunnel length

Measuring only 34.1 cm (13.4 in) in length, the short tunnel combined with the large bore is ideal for large or claustrophobic patients

## Open gantry

Patient-friendly integrated gantry design with a 101.2 x 78.3 cm (39.8 x 30.8 in) opening for greater patient comfort regardless of size

## Detector tilt

Virtually unlimited detector configurations adjustable to any study and patient type (e.g., gurney imaging, 76° cardiac)

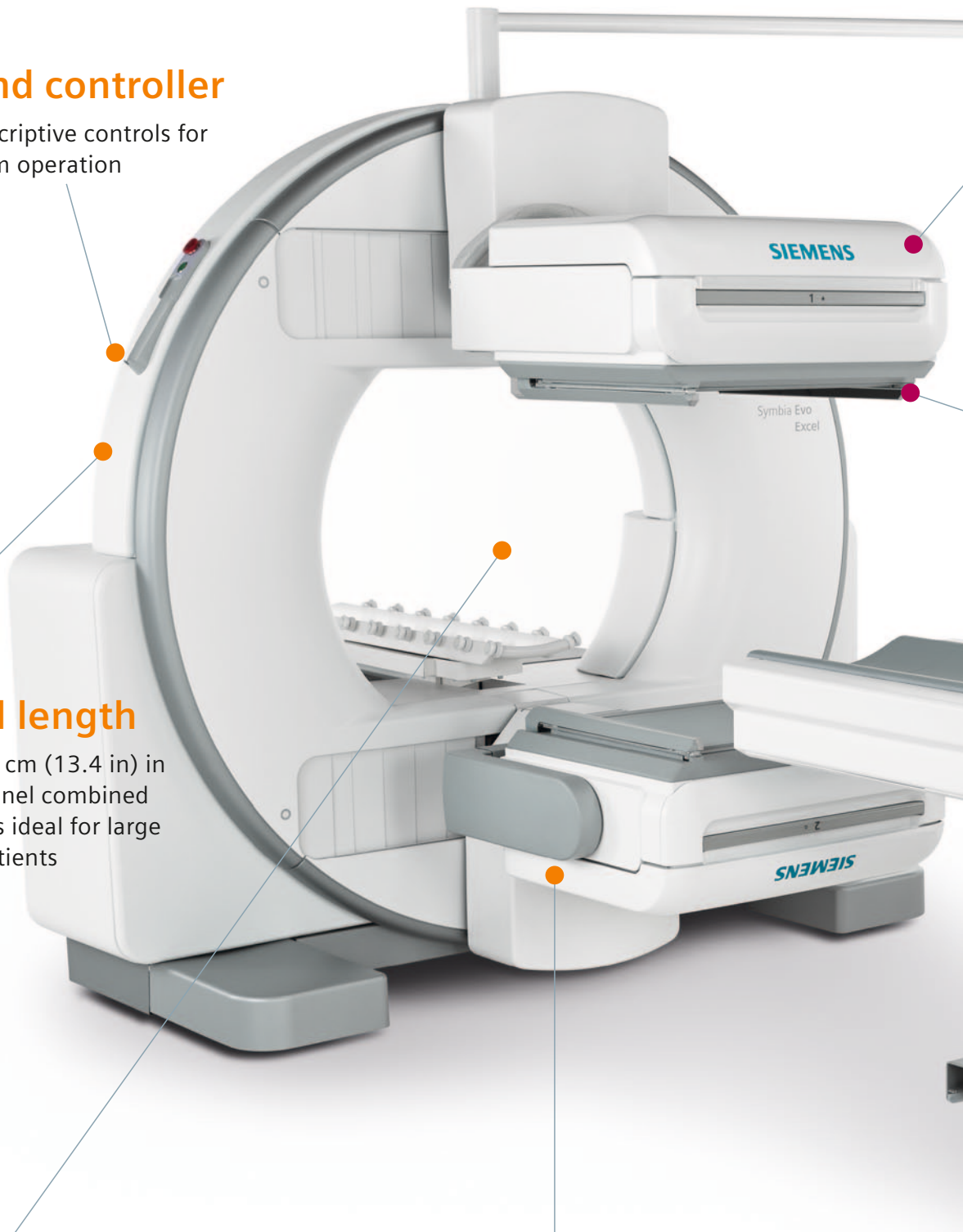

## HD detectors

High-definition digital detectors provide energy-independent performance for increased image quality and improved workflow



## Patient positioning monitor

Self-guided touch screen interface with intuitive icons enables faster patient setup

## Autocontour

Infrared body-contour system minimizes patient-to-detector distance for optimal image resolution

## Innovative bed design

Low patient bed with movable table top for easy access and ergonomic accessories for increased patient comfort

# Minimum room size

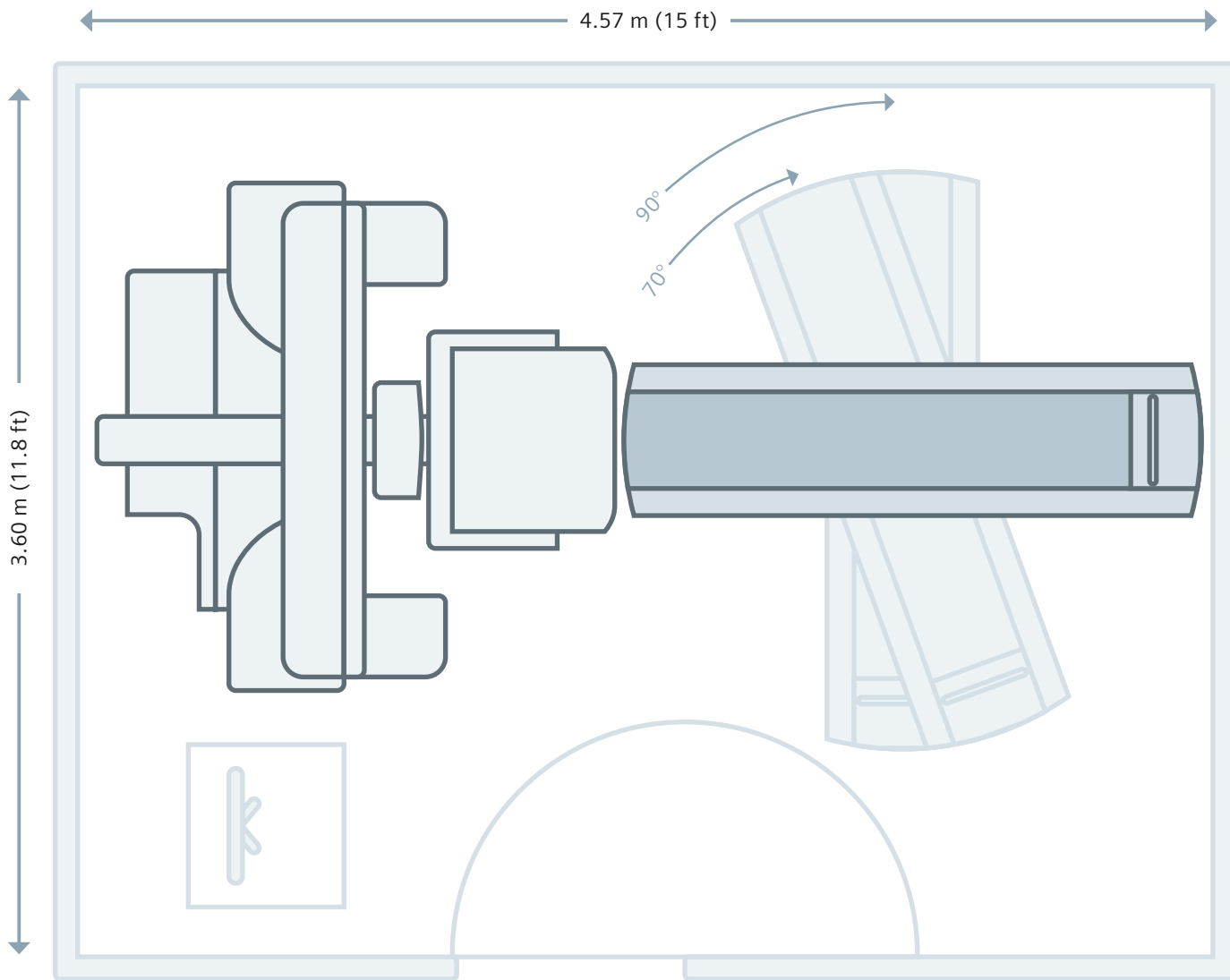

Room size	3.60 m (11.8 ft) x 4.57 m (15 ft)
Ceiling height	2.44 m (8 ft)
Hung ceiling height	2.29 m (7.5 ft)
System length	4.48 m (14.7 ft)
System width	2.16 m (7.1 ft)

# Clinical software solution

## Symbia.net

Symbia.net is an economical client-server solution for anywhere<sup>5</sup> anytime processing and reading of molecular imaging studies—from basic nuclear medicine to quantitative measurements. Symbia.net is the platform that offers maximum flexibility and investment protection.

Symbia.net can be configured as a standalone workplace for one user or as a client-server with multiple concurrent users. Symbia.net provides anywhere access from any compatible Mac or PC. With Symbia.net, app users can further leverage their investment to access all of their tools, applications and clinical cases from an iPad<sup>6</sup>.

This enables users to more easily discuss images and cases with patients, present results in tumor board meetings and gather second opinions, even from the most remote places.

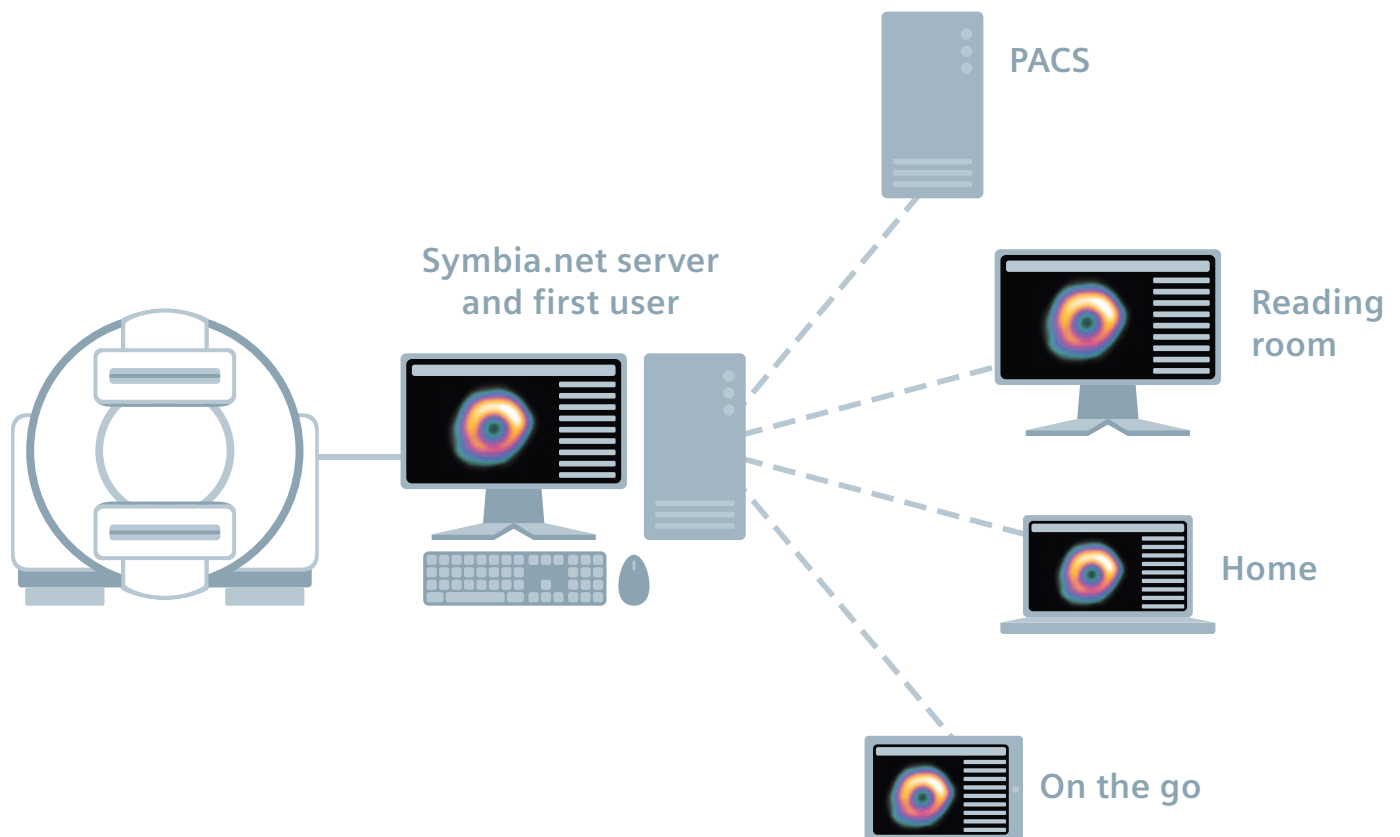

# Myocardial perfusion imaging

Reversible ischemia in a patient with multi-vessel coronary artery disease. Stress-rest myocardial perfusion SPECT performed on a 46-year-old male with chest pain and breathlessness on exertion. The scan is suggestive of severe, but reversible, myocardial ischemia consistent with triple vessel disease with severe stenosis of the left circumflex.

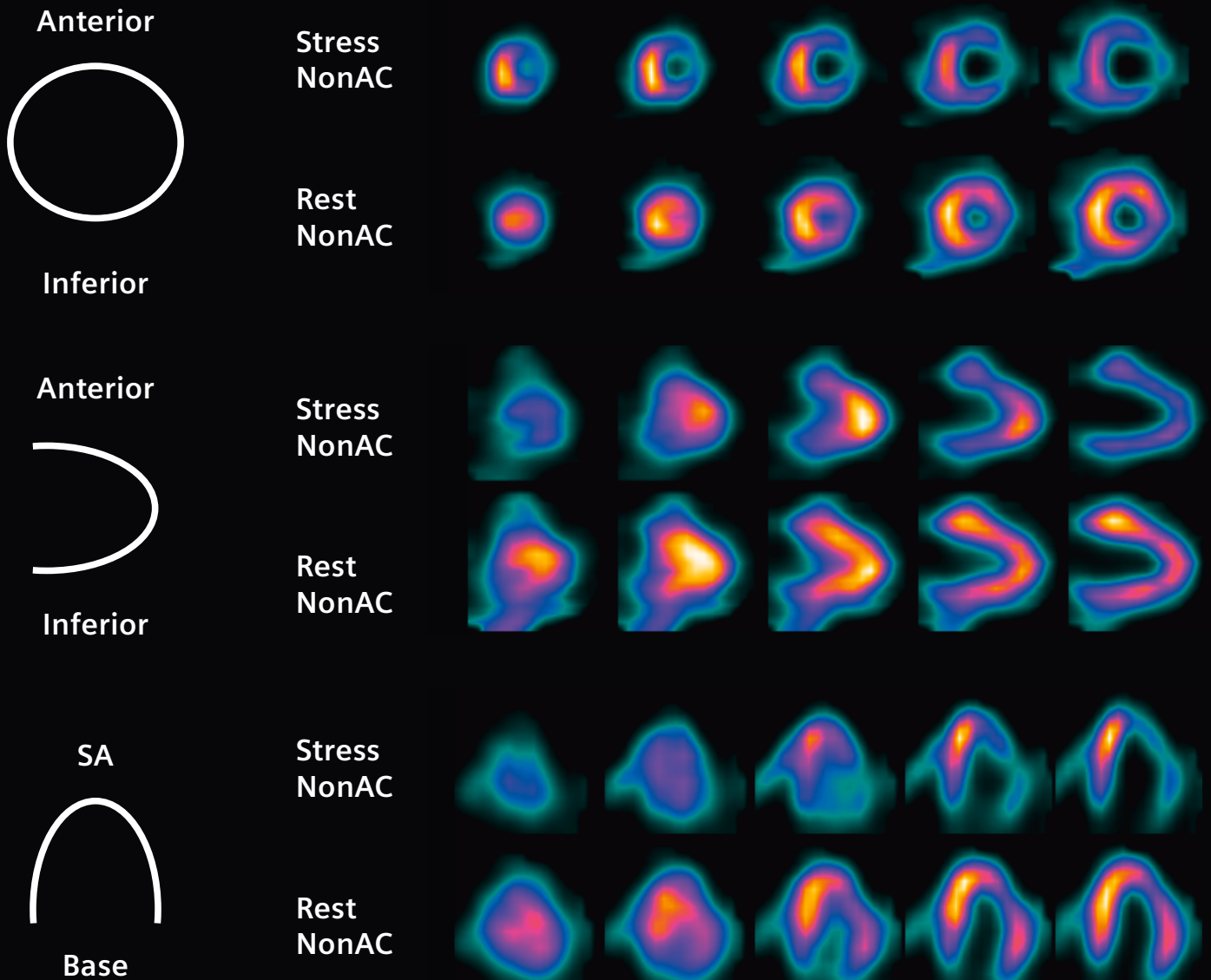

<sup>99m</sup>Tc MIBI stress rest myocardial perfusion scan shows decreased uptake of the tracer throughout the entire left ventricle at peak stress, especially in the inferolateral and lateral walls, but with complete reversibility shown by normal tracer uptake throughout the myocardium at rest. The patient was referred for revascularization.



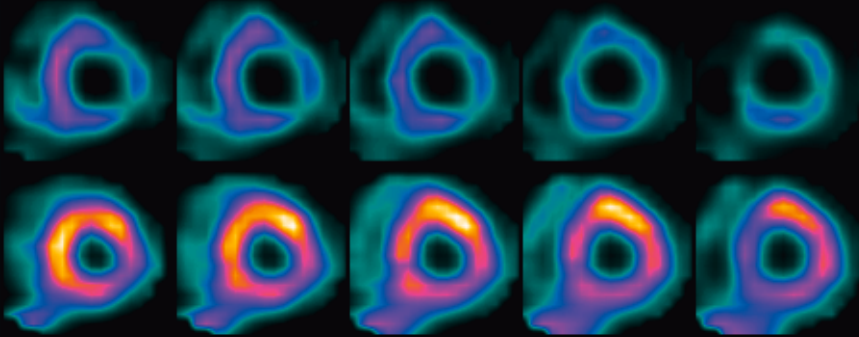

**Gated stress**

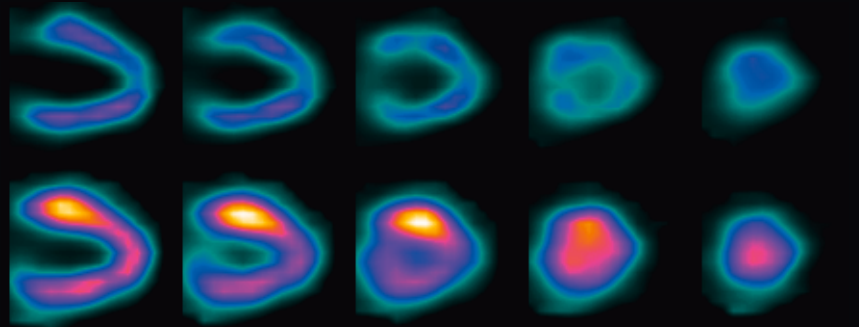
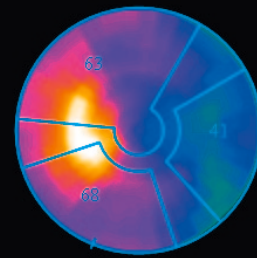

**Gated rest**

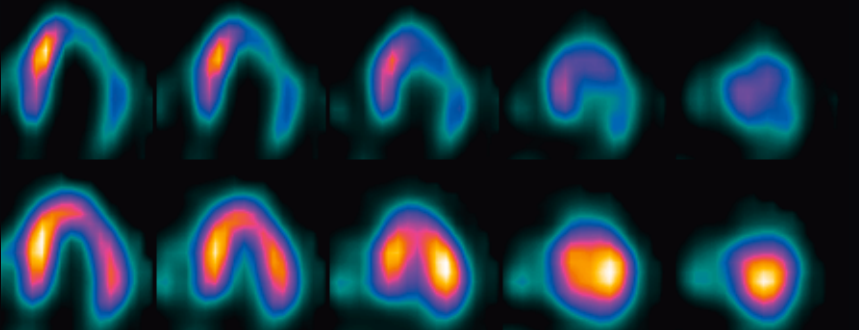
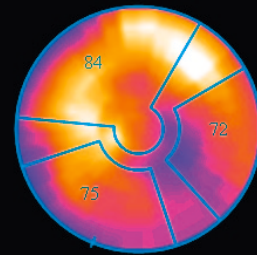

**Reversibility**

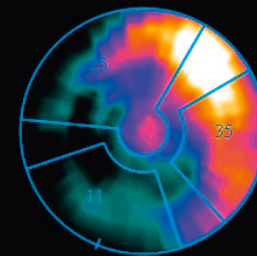

Data courtesy of radprax MVZ, Wuppertal, Germany.  
 Parameters: injected dose: stress 443 MBq (11.9 mCi) <sup>99m</sup>Tc MIBI 64 frames, 20 sec/frame;  
 rest 444 MBq (12 mCi) <sup>99m</sup>Tc MIBI 64 frames, 20 sec/frame; 3DOSEM, 8 iterations/12 subsets

# Brain perfusion imaging

An early Parkinson's disease evaluation with  $^{123}\text{I}$  FPCIT SPECT on a 78-year-old male with mild tremor and rigidity in the hand. The SPECT study shows asymmetrical bilaterally decreased uptake in the putamen with relatively preserved uptake in the caudate nucleus, suggestive of early Parkinson's disease.

Transverse view

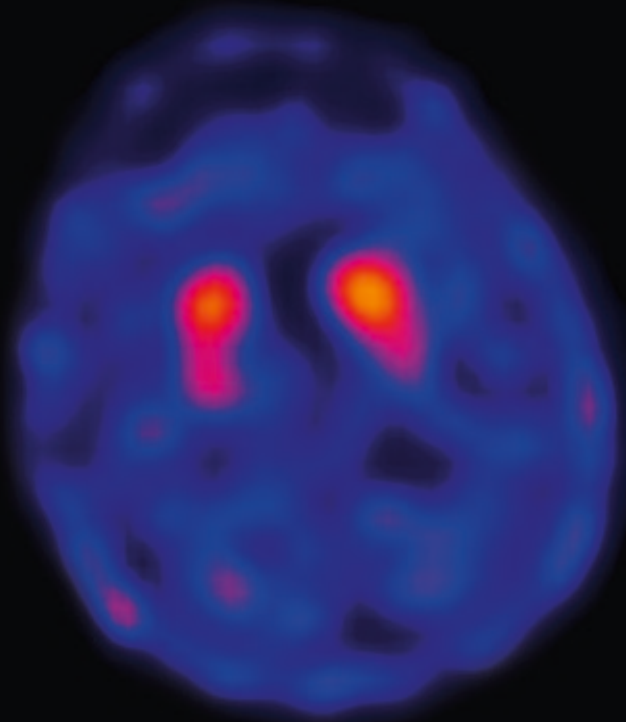

Coronal view

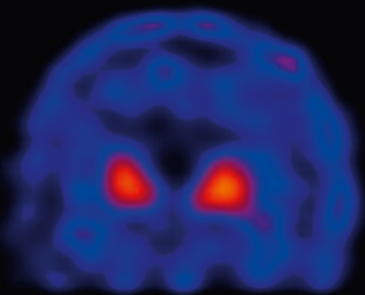

Sagittal view

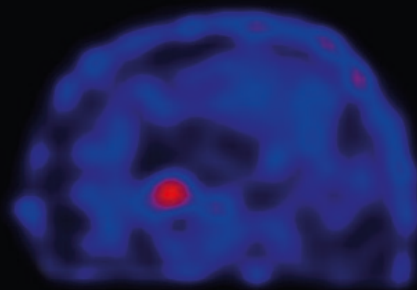

Data courtesy of radprax MVZ, Wuppertal, Germany.  
Parameters: injected dose:196 MBq (5.3 mCi)  $^{123}\text{I}$  FPCIT (DATscan); 120 frames, 25 sec/frame;  
3DOSEM reconstruction, 8 iterations/16 subsets

# Gurney imaging: gastric emptying

A gastric emptying study performed with gurney imaging on a 34-year-old obese male patient with limited mobility. Initial dynamic images were followed by a static image after one hour post-ingestion of radiolabeled meal. The study shows normal gastric emptying with negligible gastric stasis after one hour.

Planar 15 min post-ingestion

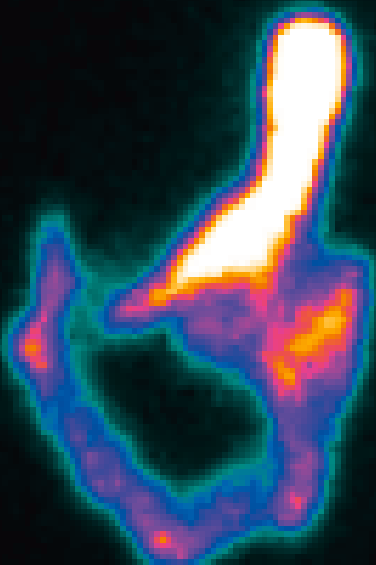

Planar 1 hour post-ingestion

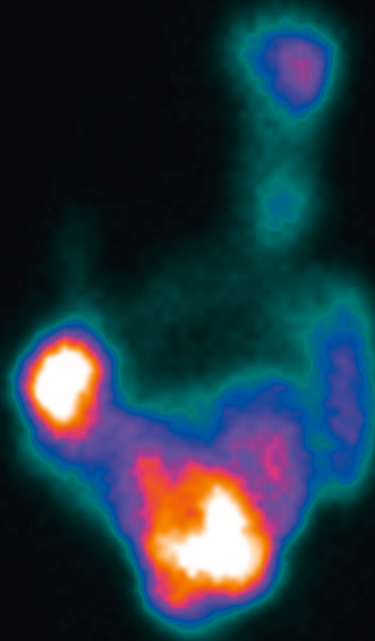

Data courtesy of radprax MVZ, Wuppertal, Germany.  
Parameters: administered dose: 75 MBq (2.1 mCi); initial dynamic planar, 50 frames/1 min per frame;  
delayed 1 hour static, 500,000 total counts

# Lung perfusion imaging

A lung ventilation/perfusion SPECT study performed on a 29-year-old male patient with suspected pulmonary embolism. The SPECT scan shows normal perfusion and ventilation in both lungs.

**Perfusion coronal**

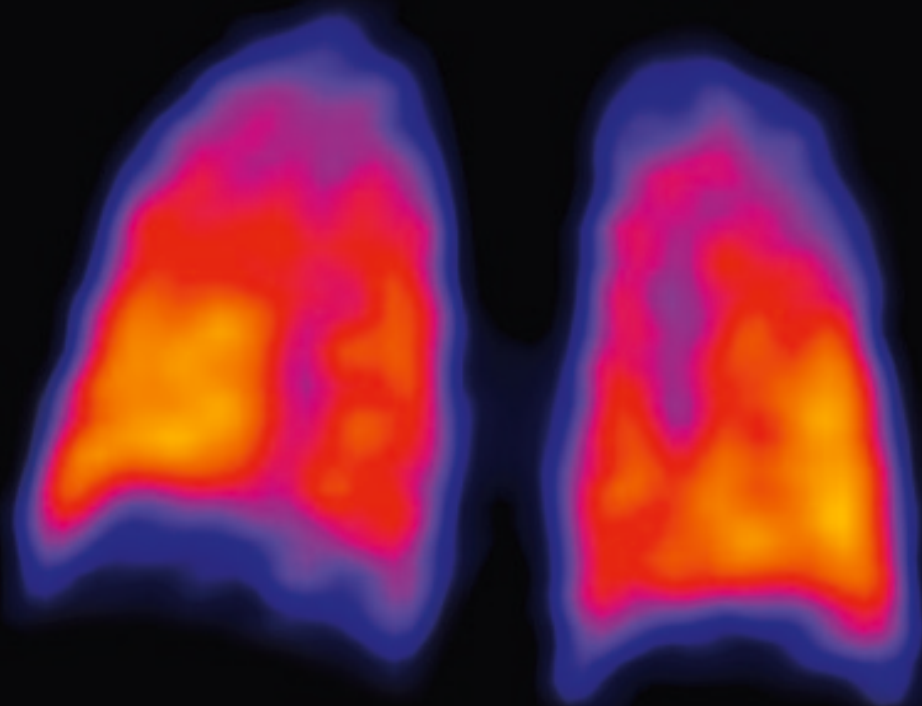

**Ventilation coronal**

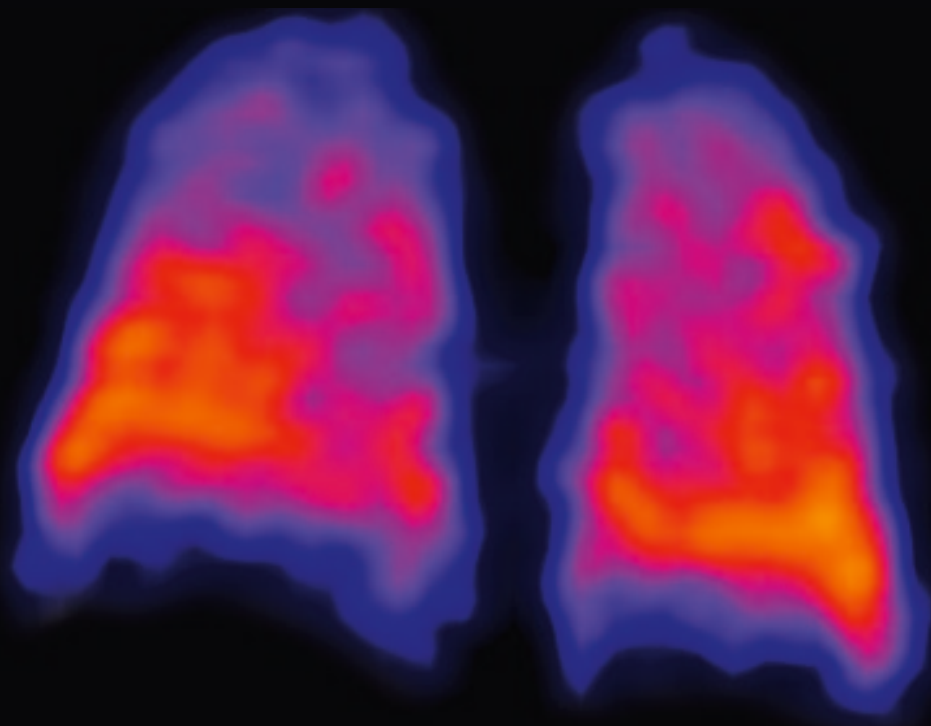

Data courtesy of radprax MVZ, Wuppertal, Germany.

Parameters: perfusion: injected dose 135 MBq (3.65 mCi)  $^{99m}\text{Tc}$  MAA; 64 frames, 15 sec/frame; 3DOSEM reconstruction, 8 iterations/8 subsets; ventilation  $^{99m}\text{Tc}$  DTPA aerosol; 64 frames, 15 sec/frame; 3DOSEM, 6 iterations/8 subsets

Perfusion transverse

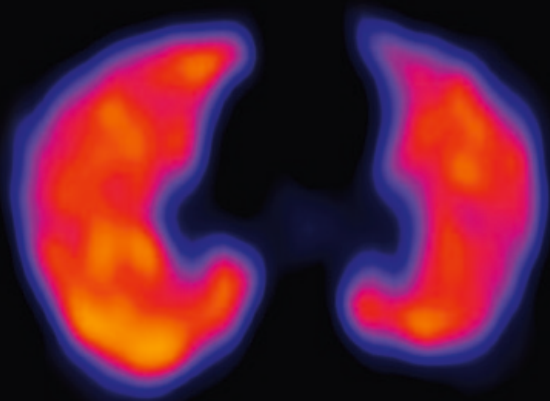

Perfusion sagittal

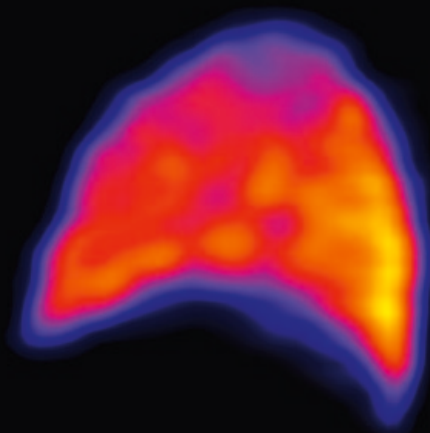

Ventilation transverse

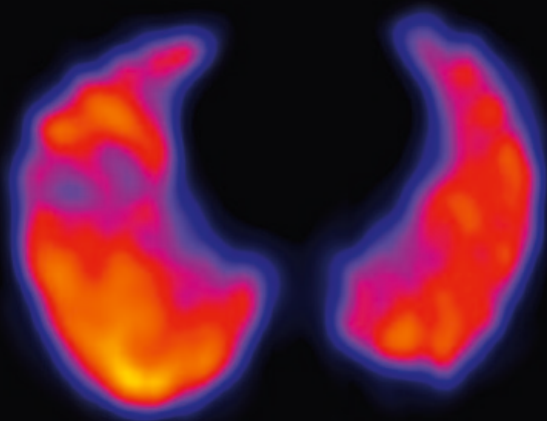

Ventilation sagittal

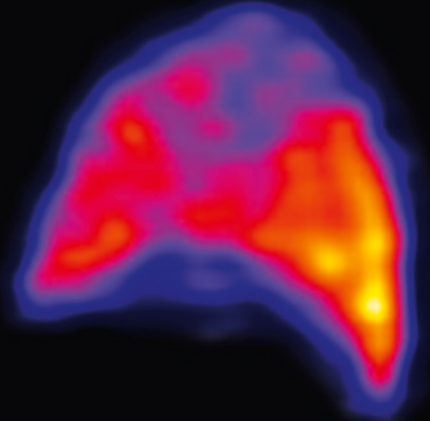

# Bone imaging

A primary bone tumor in the clavicle found in a 62-year-old woman. The SPECT study shows focal hypermetabolism in an expansible lesion involving the middle third of the clavicle. No other skeletal lesions were visualized. The study is suggestive of a primary bone tumor in the clavicle without metastases. A biopsy was required for histopathological confirmation.

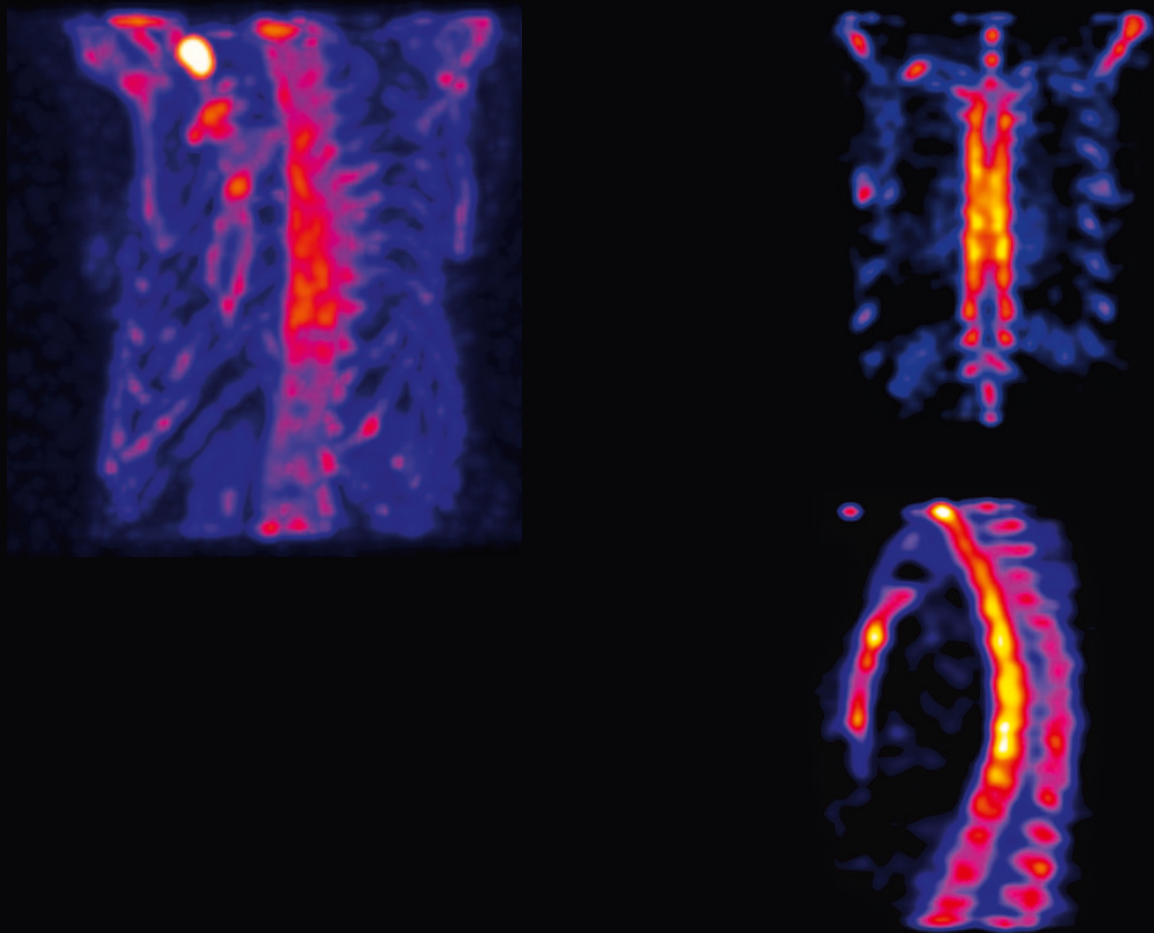

Data courtesy of radprax MVZ, Wuppertal, Germany.  
Parameters: injected dose: 674 MBq (18.22 mCi); 64 frames, 20 sec/frame;  
3DOSEM reconstruction, 8 iterations/4 subsets

# $^{111}\text{In}$ Octreotide<sup>7</sup> SPECT

A normal  $^{111}\text{In}$  Octreotide SPECT performed on a 20-year-old male patient with history of an intestinal neuroendocrine tumor that was treated with surgery. The study shows normal distribution of the tracer in the liver, spleen and gallbladder, with no indication of metastasis.

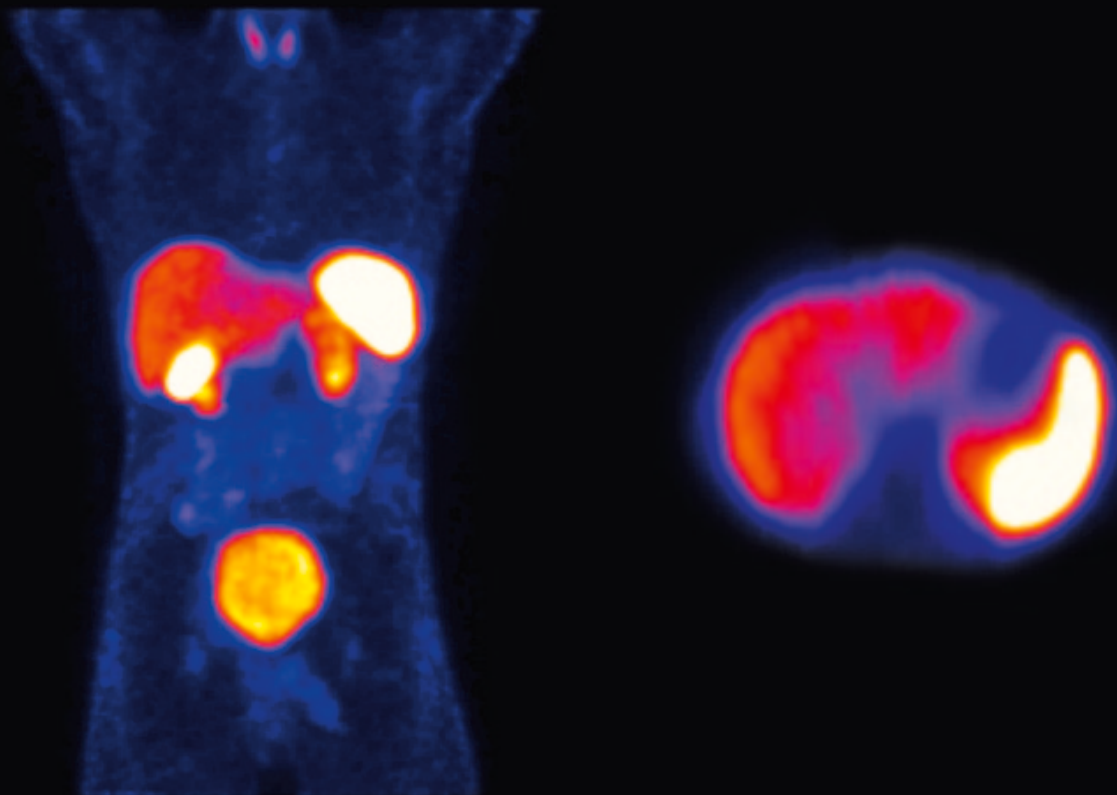

Data courtesy of radprax MVZ, Wuppertal, Germany.  
Parameters: injected dose: 673 MBq (18.2 mCi); 64 frames, 20 sec/frame;  
3DOSEM reconstruction, 6 iterations/2 subsets/2 bed positions

**Global Siemens Headquarters**

Siemens AG  
Wittelsbacherplatz 2  
80333 Muenchen  
Germany

**Global Siemens Healthcare Headquarters**

Siemens AG  
Healthcare Sector  
Henkestr. 127  
91052 Erlangen  
Germany  
Telephone: +49 9131 84-0  
[www.siemens.com/healthcare](http://www.siemens.com/healthcare)

**Global Business Unit**

Siemens Medical Solutions USA, Inc.  
Molecular Imaging  
2501 N. Barrington Road  
Hoffman Estates, IL 60192-2061  
USA  
Telephone: +1 847 304 7700  
[www.siemens.com/mi](http://www.siemens.com/mi)

**Legal Manufacturer**

Siemens Medical Solutions USA, Inc.  
Molecular Imaging  
2501 N. Barrington Road  
Hoffman Estates, IL 60192-2061  
USA  
Telephone: +1 847 304 7700  
[www.siemens.com/mi](http://www.siemens.com/mi)

<sup>1</sup> Symbia Evo Excel is not commercially available in all countries. Due to regulatory reasons its future availability cannot be guaranteed. Please contact your local Siemens organization for further details.

<sup>2</sup> Patients up to 227 kg (500 lbs).

<sup>3</sup> Based on competitive literature available at time of publication. Data on file.

<sup>4</sup> Compared to previous systems.

<sup>5</sup> Requires network connection and minimum hardware requirements. Server management with at least one client required for iPad access.

<sup>6</sup> Symbia.net for iPad is for non-diagnostic use.

<sup>7</sup> <sup>111</sup>In Octreotide is not currently recognized by the U.S. Food and Drug Administration (FDA) or other regulatory agencies as being safe and effective, and Siemens does not make any claims regarding its use.

Order No. A91MI-10420-1C-7600 | Printed in the USA | MI-2068.KF.WB.TW.1500 | © 10.2014, Siemens AG

Trademarks and service marks used in this material are property of Siemens Medical Solutions USA or Siemens AG. All other company, brand, product and service names may be trademarks or registered trademarks of their respective holders.

All comparative claims derived from competitive data at the time of printing. Data on file. Siemens reserves the right to modify the design and specifications contained herein without prior notice. As is generally true for technical specifications, the data contained herein varies within defined tolerances. Some configurations are optional. Product performance depends on the choice of system configuration.

Please contact your local Siemens Sales Representative for the most current information or contact one of the addresses listed below. Note: Original images always lose a certain amount of detail when reproduced.

All photographs © 2014 Siemens Medical Solutions USA, Inc. All rights reserved.